

End fittings

Metal sliding tip, nickel-plated, adjustable for both end-on and hook-on measurements

Internal measuring

With the IN-OUT, VISO, X 4, TOP and TOP-M models the internal measurement can conveniently be read directly from the top sight window. For other models the case length is to be added.



Pocket Tapes

Pocket tapes manufactured by BMI are versatile with regard to their use as their users' demands are diverse.

Longitudinal, internal measuring, radii, mm/mm graduation mm/ inch graduation, individual case designs and much more.

There is almost no limit to your imagination. Owing to the fact that these pocket tapes are manufactured in our own works there are many design options, even for small quantities.

Our main focus is of course on precise measuring, perfect handling and long working life.

ADVANTAGES

- Durability in rough work environment through rust protection of the tapes (phosphate ground coating)



- BMI pocket tapes have a transparent coating as wearing protection, 10 times stronger than any other non-abrasive coatings!
- Long working life of the return lock spring owing to a special spring band steel
- Sophisticated interior: inserted winding coils or distance washers ensure perfectly smooth running
- Robust high-impact ABS or polyamide case
- Tapes with mm-graduation EEC pattern approved, suitable for calibration
- Accuracy acc. to EEC class II
 - 2 m ± 0.7 mm
 - 3 m ± 0.9 mm
 - 5 m ± 1.3 mm
 - 8 m ± 1.9 mm

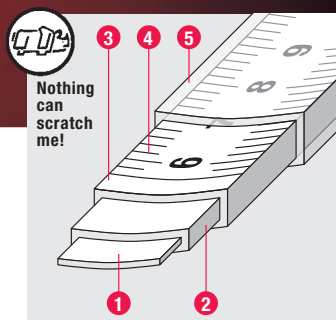

Tape structure

- 1 Concaved, tempered spring blade steel of high stability
- 2 Anticorrosive phosphate coating
- 3 Synthetic resin, stoved
- 4 Printed graduation with red meter figures
- 5 Clear varnish to protect against wear, stoved

You will recognize high-quality measuring tapes by these imprints:

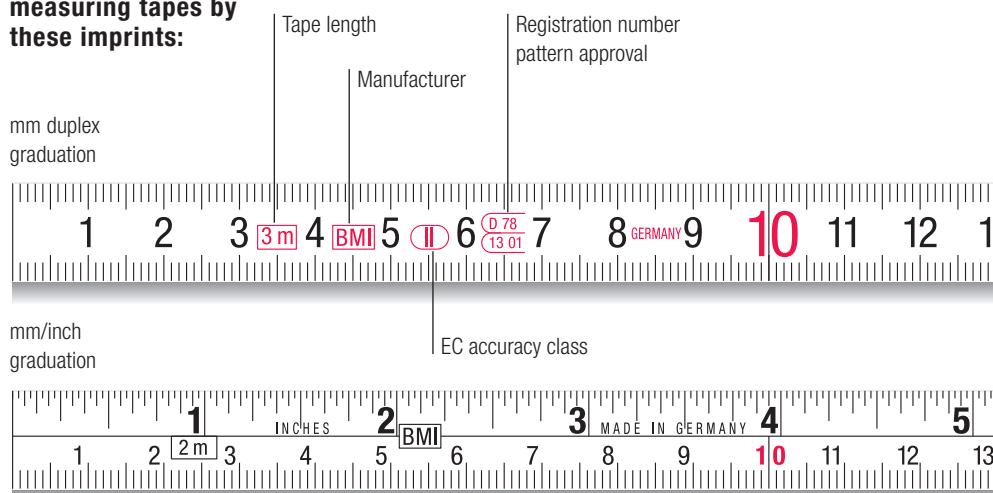

401 VARIO

Elegant and ergonomically shaped high-impact ABS plastic case*. A special mechanism ensures smooth running of the blade. Lock lever operates automatic blade return. VARIO 5m with carrying strap. Lengths 2, 3 and 5 m with mm- or mm/inch-graduations.

Case dimensions:

2 + 3 m: 60 x 58 x 19 mm

5 m: 75 x 70 x 26 mm



Length	2 m	2 m/79"	3 m	3 m/122"	5 m	5 m/197"
Graduation	mm	mm/inch	mm	mm/inch	mm	mm/inch
Width	13 mm	13 mm	13 mm	13 mm	16 mm	16 mm
Model no.	401 241	401 251	401 341	401 351	401 541	401 551
Price						
Surcharge for clip						
Surcharge for single packaging						

401 VARIO R

Stainless steel model for special applications. Owing to the use of chrome-nickel steel absolutely rustfree. Otherwise like VARIO.



Length	2 m	2 m/79"	3 m	3 m/122"	5 m	5 m/197"
Graduation	mm	mm/inch	mm	mm/inch	mm	mm/inch
Width	13 mm	13 mm	13 mm	13 mm	16 mm	16 mm
Model no.	401 243	401 253	401 343	401 353	401 543	401 553
Price						
Surcharge for clip						
Surcharge for single packaging						

* also available with beltclip

Refer to our General Terms of Payment and Delivery

404 IN-OUT

Pocket tape with top sight window for internal measuring (see page 30). The graduation in the window is not displayed upside down (no reading errors possible). Blade lock. Polyamide case. Free-running blade in push-pull execution. Lengths 2+3 m with mm- or mm/inch-graduations. Blade width 13mm. Case dimensions: 60 x 60 x 21 mm



Length	2 m	2 m/79"	3 m	3 m/122"
Graduation	mm	mm/inch	mm	mm/inch
Width	13 mm	13 mm	13 mm	13 mm
Model no.	404 241	404 251	404 341	404 351
Price				
Surcharge for clip				
Surcharge for single packaging				

405 VISO

The special measuring tape with 3 functions
 1. Longitudinal measuring
 2. Internal measuring (see page 30)
 3. Circles
 The graduation in the window is not displayed upside down (no reading errors possible). Blade lock. Polyamide case. Free-running blade in push-pull execution. Lengths 3 m with mm- or mm/inch-graduations. Blade width 16 mm. Case dimensions: 65 x 65 x 25 mm

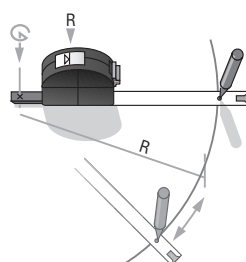

The steel stylus integrated in the swing-out arm allows 3 m radii to be drawn

Length	3 m	3 m/122"
Graduation	mm	mm/inch
Width	16 mm	16 mm
Model no.	405 343	405 353
Price		
Surcharge for clip		
Surcharge for single packaging		

Pocket Tapes

407 TOP / 406 TOP-M

Internal measuring tape (see page 30) without lock. Top sight window with magnifying effect. The graduation in the window is not displayed upside down (no reading errors possible). Polyamide case. Free-running blade in push-pull execution. Lengths 3 m with mm- or mm/inch-graduations. Blade width 13 mm. Case dimensions: 65 x 65 x 21 mm



406 TOP-M: with steel base



Length	2 m	2 m/79"	3 m	3 m/122"	2 m	2 m/79"	3 m	3 m/122"
Graduation	mm	mm/inch	mm	mm/inch	mm	mm/inch	mm/inch	mm/inch
Width	13 mm	13 mm	13 mm	13 mm	13 mm	13 mm	13 mm	13 mm
Model no.	407 241	407 251	407 341	407 351	406 241	406 251	406 341	406 351
Price								
Surcharge for clip								
Surcharge for single packaging								

408 X4

The most versatile tape with 4 functions :
 1. Longitudinal measuring
 2. Internal measuring (see page 30)
 3. Radii drawing
 4. Level
 The graduation in the window is not displayed upside down (no reading errors possible). Blade lock. Polyamide case. Free-running blade in push-pull execution. Lengths 3 m with mm- or mm/ inch-graduations. Blade width 13 mm. Case dimensions: 60 x 80 x 20 mm

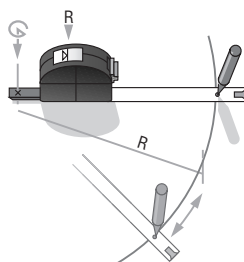
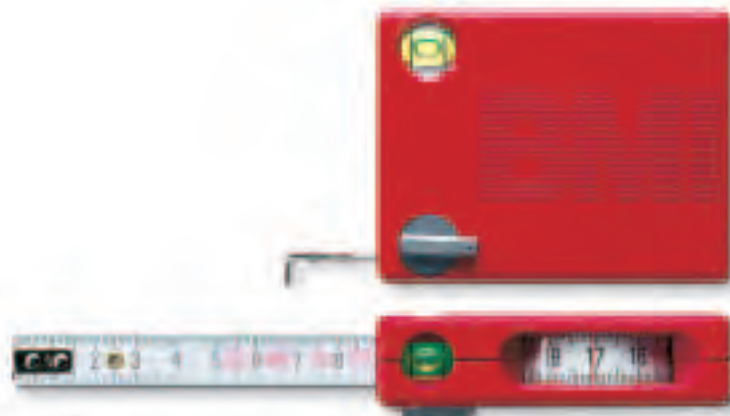

The steel stylus integrated in the swing-out arm allows 3 m radii to be drawn.

Length	3 m	3 m/122"
Graduation	mm	mm/inch
Width	13 mm	13 mm
Model no.	408 341	408 351
Price		
Surcharge for clip		
Surcharge for single packaging		

420 MAX

MAX, the "extra-wide" blades by BMI. Extreme blade stability. High-impact ABS plastic case. Automatic blade return. Shock-absorbing buffer at the blade inlet. Modern technology for long working life. Retractable belt clip, ergonomically designed lock to ensure perfect handling. Lengths 3, 5 and 8 m with mm- or mm/inch-graduations

Blade widths:
3+5 m: 19 mm
8 m: 25 mm

Case dimensions:
3+5 m: 82 x 75 x 38 mm,
8 m: 90 x 83 x 46 mm



Length	3 m	3 m/120"	5 m	5 m/197"	8 m	8 m/324"
Graduation	mm	mm/inch	mm	mm/inch	mm	mm/inch
Width	19 mm	19 mm	19 mm	19 mm	25 mm	25 mm
Model no.	420 341	420 351	420 541	420 551	420 841	420 851
Price with single packaging						

472 twoComp

Pocket tape with robust tape operating mechanism. High-impact ABS plastic case. Automatic blade return. Blade lock. Belt clip. Lengths 2, 3, 5 and 8 m with mm- or mm/inch-graduations.

Blade width
2 + 3 m: 16 mm
5 m: 19 mm
8 m: 25 mm

Case dimensions:
2 m: 60 x 60 x 32 mm
3 m: 60 x 60 x 32 mm
5 m: 70 x 70 x 36 mm
8 m: 80 x 80 x 45 mm



Length	2 m	3	5 m	8 m
Graduation	mm	mm	mm	mm
Width	16 mm	16 mm	19 mm	25 mm
Model no.	472 241	472 341	472 541	472 841
Price Single Blister packaging				

Pocket Tapes

490 MET

The pocket tape with heat-resistant zinc die-cast case with chrome finish.

Automatic, lock-operated blade return.

Lengths 2 + 3 m with mm-graduations.

Blade width 13 mm.

Case dimensions:

60 x 58 x 19 mm

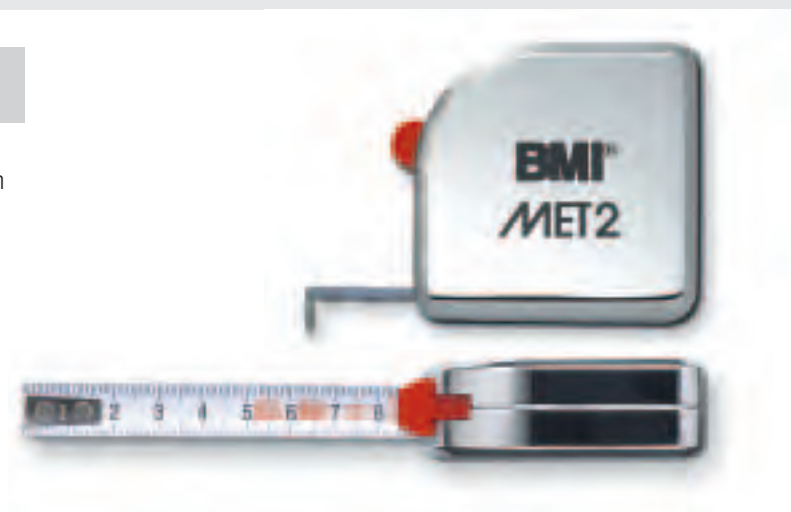

Length	2 m	2 m/79"	3 m	3 m/120"
Graduation	mm	mm/inch	mm	mm/inch
Width	13 mm	13 mm	13 mm	13 mm
Model no.	490 241	490 251	490 341	490 351
Price				
Surcharge for clip				
Surcharge for single packaging				

QUICKY

The folding rule is compact...
QUICKY is more compact

The folding rule is robust...
QUICKY is more robust

The folding rule is accurate...
QUICKY is more accurate

This "cool" piece is unique in the market!

Due to a special treatment of the refined steel tape, the tape **unrolls on its own**, activated by a short hands' movement.

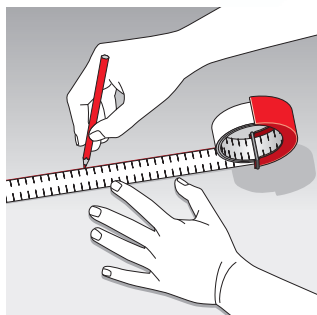

The unrolled tape always has a continuous straight edge, therefore Quicky is ideal for drawing continuous lines.

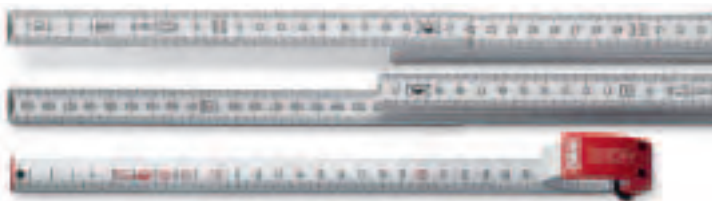

The tape lies flatly on the table, allowing precise marking of measurements (a folding rules' either remains "in the air" or has to be read inverted).

A rubber ring at the lower end of the tape frame supports the **go** or **stop**, depending on the position of the hand holding the frame.

Technical details:

- Refined steel tape, white enamelled
- absolutely waterproof
- 2 m long and 16 mm wide
- Accuracy according EC class II



...rolls out on its own!



Length	2 m	2 m/79"
Graduation	mm	mm/inch
Width	16 mm	16 mm
Model no.	428 24 1030	428 25 1030
Price		

incl. Blister packaging

"QUICKY in action" on www.bmi.de!