



These BMI advantages are your benefit:



Frame designed according to ergonomic requirements



Can be modified from right-hand to left-hand operation within seconds



Ball bearings resistant to wear for most convenient handling



Aluminium profiles resistant to bending



Wear-resistant tape outlet of high tech plastic

Measuring Tapes, Frame- and Case-Type

Measuring tapes by BMI, that means patented features which ease the work of professionals and "do it yourselfers" alike, protect the tool itself and thus save time and money. All the three frame series are ergonomically designed, can be modified from right-hand to left-hand operation in no time, and are even equipped with slide or ball bearings.

The FLEXTOP tip which is optionally available without extra charge prevents breakage at the tape end. Our broad range of tape designs with regard to lengths, materials and graduation lay-out provide the user with the perfect solution for every measuring task. The RADIUS case series also includes many of these features, of course.

Measuring tapes by BMI are certainly the right choice

ADVANTAGES

- Tapes comply to the EC accuracy classes I, II or III. Many of them are EC type-approved and are thus suitable for calibration
- Frames designed according to ergonomic requirements
- Can be modified from right-hand to left-hand operation within a second
- Ball bearings resistant to wear for most convenient handling of the ERGOLINE frame
- Low-wear slide bearings for BASIC and STANDARD frames
- The FLEXTOP tip prevents breakage at the tape commencement (see page 12)
- Park position for the tape commencement ring and crank arm



**Nothing
can scratch
me!**

- Measuring tapes with this symbol have a transparent coating as wearing protection, 10 times stronger than any other non-abrasive coatings! You will obtain many of these advantages from BMI only, as they have been patented!



Park position for tape commencement ring



Park position for crank arm

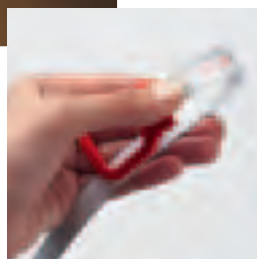

The FLEXTOP tip prevents breakage at the tape commencement



RADIUS case with easy grip soft-touch surface

UAB "KARE TECHNIKA"
www.kare.lt
ERGOLINE

Ergonomically shaped frame with easy-to-grip, soft rubber protrusions.
Park position for crank arm and tape commencement ring.
Ball bearings for highest winding convenience.

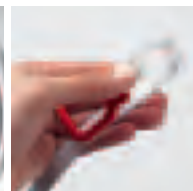

STANDARD

STANDARD frame series
Like ERGOLINE, but with plastic slide rings instead of ball bearings,
without soft rubber protrusions.

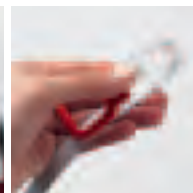
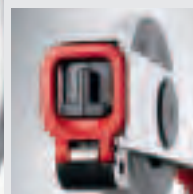

BASIC frame series
Ultrasonic welded high-impact plastic frame. Important features as in ERGOLINE, but with slide rings instead of ball bearings.



We deliver long-length tapes with STANDARD V-frame



RADIUS

RADIUS case series
Ergonomically shaped case with with large crank arm and park position for commencement ring. Slide bearing shells for highest winding comfort. With easy grip soft-touch surface

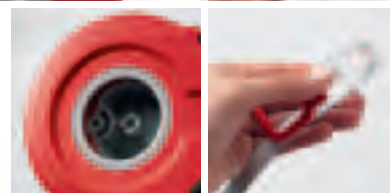

555 case series

555 case series

Handy case tape made of shock-resistant plastics.

Carrying strap. **Tape width 10 mm**



Brass frames

Dipping tapes, suitable for calibration (large fig.)

Brass frames for stainless steel tapes small fig.)



including weight 476,
please see page 13 for description,
suitable for calibration

Graduation lay-out

Graduations available.
Custom made graduations on request



1: (cm)



2: (cm/cm)



3: (cm/inch)



4: (mm)



5: (mm/inch)

Measurement Commencements

A:
Measurement commencement
approx. 10 cm after end fitting



B:
Measurement commencement
at front fitting edge



C:
Measuring commencement
at front ring edge



L:
Measurement commencement
at the bottom edge of the weight

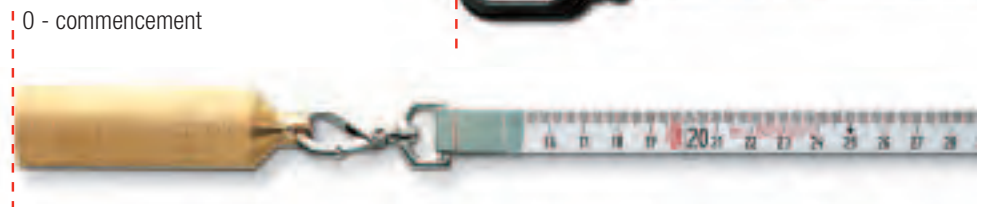

Tape Commencements

For all steel measuring tapes
13 mm, pull ring made of
break-proof plastic, 2 notches
for weights.

**This commencement will be
delivered when no special
commencement is mentioned**



F:

FLEXTOP tip made of trans-
parent, highly-flexible plastic;
reliably prevents breakage at the
tape commencements.

For all steel measuring tapes
13 mm, pull ring made of
break-proof plastic, 2 notches
for weights.

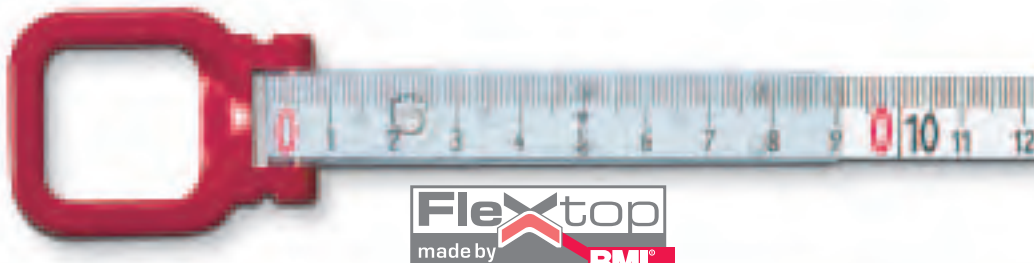

BHF:

Hookring with FLEXTOP tip,
measurement commencement B



CHF:

Hookring with FLEXTOP tip,
measurement commencement C



M:

Metal commencement with
metal ring





Weight 11
Brass, cylindrical,
no graduation,
length 170 mm,
diameter 24 mm,
weight 500 g
(can be removed
from the tape)

Order No.
340 00 11



Weight 16
Stainless steel
cylindrical, engraved
mm scale on one
and inch scale on
the other side,
length 113 mm,
diameter 24 mm,
weight 400 g
(cannot be removed
from the tape)

Order No.
340 02 16

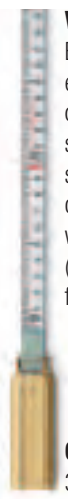

Weight 14
Brass cylindrical,
engraved mm scale
on one and inch
scale on the other
side, length 80 mm,
diameter 24 mm,
weight 300 g
(cannot be removed
from the tape)

Order No.
340 02 14



Weight 10
Brass cylindrical,
engraved mm scale
on one and inch
scale on the other
side, length 89 mm,
diameter 24 mm,
weight 300 g
(can be removed
from the tape)

Order No.
340 02 10



Weight 30
Brass cylindrical,
torpedo-shaped ends,
mm scale engraved
on one side, length
153 mm, diameter
30 mm, weight 700 g
(cannot be removed
from the tape),
**suitable for
calibration**

Order No.
340 02 30



**Weight 31 according
to IPM Standard**
Brass cylindrical,
torpedo-shaped ends,
mm scale engraved
on one side,
length 156 mm,
diameter 30 mm,
weight 700 g (can be
removed from the tape)

Order No.
340 02 31



Weight 476
Brass cylindrical,
length 100 mm,
diameter 45 mm,
weight 660 g (cannot be
removed from the tape),
**suitable for
calibration**

see order overview at
page 22

Custom made measuring tapes

For example self adhesive tapes with graduation
from right to left side

We are pleased to produce custom made measuring tapes for you.
Please contact us!

Interesting facts about measuring tapes

Accuracy:

BMI measuring tapes have been manufactured according to the highest quality standards in Germany. Within the scope of product liability we guarantee for the observation of tolerances according to EC accuracy classes for metric graduations.

Our standard is

- for stainless steel tapes: class II (class I option for an extra charge)
- for polyamid-coated measuring tapes in cm-graduation, BMI-ISOLAN: class I
- for glass fibre reinforced measuring tapes: class II or III

Tolerances according to EC accuracy classes:

- I: ± 1.1 mm in 10 m
- II: ± 2.3 mm in 10 m
- III: ± 4.6 mm in 10 m

High-quality measuring tapes can be recognized from the different imprints at the tape end. There you will find the manufacturer's label, the number of the EC type approval, the EC class accuracy, the reference temperature and the tension for which the manufacturer guarantees the observation of measurement tolerances according to the EC class accuracy.

Certificate of Conformity:

For all measuring tapes with a metric graduation we will issue a certificate of conformity, if required. Compliance of the tape widths with the respective EC type approval and the observation of measuring tolerances according to EC accuracy classes are certified herein (Surcharge).

Calibration:

All measuring tapes with a metric graduation are EEC pattern approved and can be calibrated for an extra charge. This calibration is valid in all EU member states. Some dipping tapes, however, are exempted.

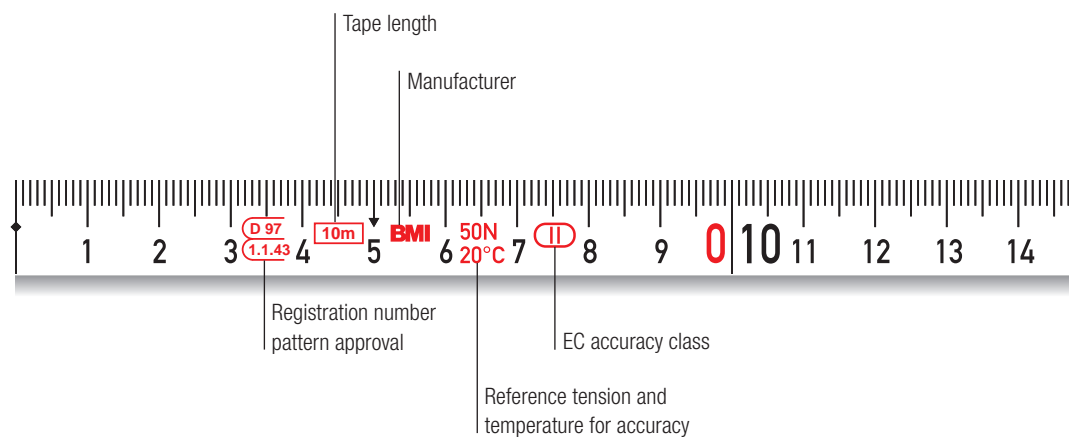

Recommended usage

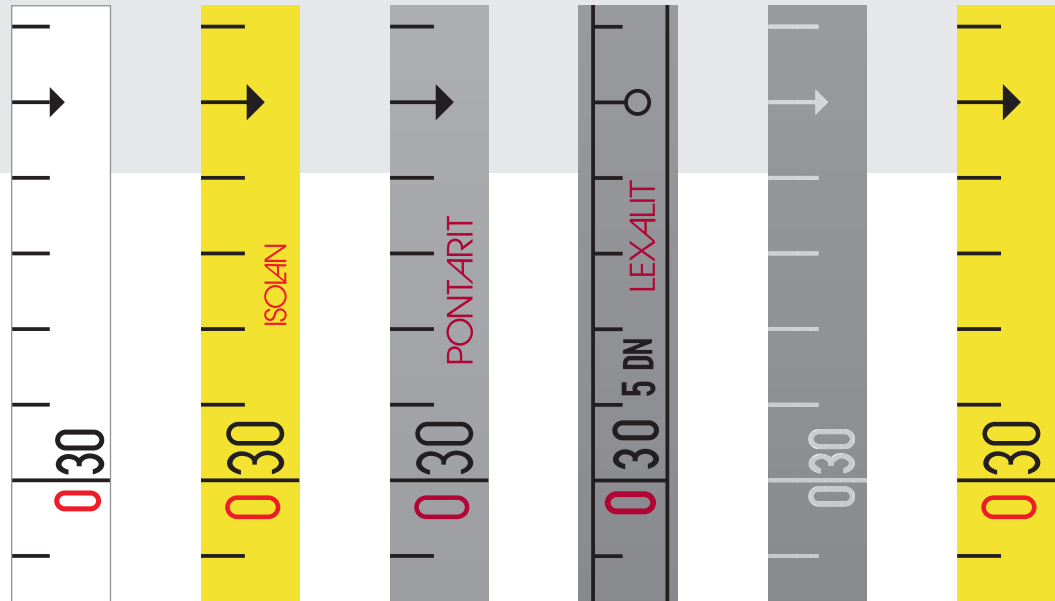

Tape quality:	Steel, white enamelled, printed graduation	Steel, yellow enamelled, printed graduation, with polyamide coating, "ISOLAN"	Refined steel, printed graduation, "PONTARIT"	Refined steel, deep etched graduation, "LEXALIT"	Refined steel, high etched graduation,	Glassfibre, reinforced plastic, printed graduation
Characteristics:						
stainless	+	++	+++	+++	+++	+++
acid-proof		+			+++	
proved for oil					+++	
non-conductive (insulated)						+++
unbreakable/flexible	+	++	++	++	++	+++
resistant to wear	++	+++	+	+	++	+
readability	+++	+++	++	++	+	+++
Recommended use	universal, normal use	universal, toughest demands	also in wet environment	also in wet environment	also in chemical aggressive environment	universal, weaker demands
Equipment options:						
Graduation	cm, cm/cm, mm, mm/inch	cm, cm/cm, mm, mm/inch	cm, cm/cm, mm, mm/inch	cm	cm, cm/cm, mm, mm/inch	cm, cm/cm, cm/inch
Lengths	10 to 100 m	10 to 100 m	10 to 100 m	10 to 50 m	10 to 100 m	10 to 100 m
Measurement commence.	A, B, C, L	A, B, C, L	A, B, C, L	A, B, C	A, B, C, L	A, B, C
Tape commencements	all	all	all	all	all	all, but no Flextop
Accuracy:						
EC class	II, (I possible)	II, (I possible)	II, (I possible)	II	II, (I possible)	Graduation II on one side graduation III on two sides
Suitability for calibration	all variants on A and B, CH, L30	all variants on A and B, CH, L30	all variants on A and B, CH, L30	all variants on A and B, CH, L30	all variants on A and B, CH, L30, L476	all variants on A and B, CH

White enamelled 13 mm



This is how your order no. could look like:

301 01 1 010 A F

white enamelled measuring tape, printed graduation

ERGOLINE

Size 1/2



Type	Frame size	Graduation number	Length meter	Measurement commencement	Tape commencement	Price
301	01	X	010	X	X	
301	01	X	015	X	X	
301	01	X	020	X	X	
301	02	X	025	X	X	
301	02	X	030	X	X	
301	02	X	050	X	X	

Size 3/4



Type	Frame size	Graduation number	Length meter	Measurement commencement	Tape commencement	Price
301	03	X	050	X	X	
301	04	X	100	X	X	

STANDARD

Size 1/2



Type	Frame size	Graduation number	Length meter	Measurement commencement	Tape commencement	Price
501	01	X	010	X	X	
501	01	X	015	X	X	
501	01	X	020	X	X	
501	02	X	025	X	X	
501	02	X	030	X	X	
501	02	X	050	X	X	

Size 3/4



Type	Frame size	Graduation number	Length meter	Measurement commencement	Tape commencement	Price
501	03	X	050	X	X	
501	04	X	100	X	X	

Please choose numbers and capital letters of desired tape features and transfer them to your order no.

Graduations

1 (cm)	
4 (mm)	
5 (mm/inch)	

25% surcharge

Measurement commencements

A	
B	
C	
L	

Please order weight separately, see p.13 for model variants

Tape commencements (optional)

F (FLEXTOP)	
HF (hookring flexible, surcharge)	
M (metal ring)	

for measurement commencement B
for measurement commencement C

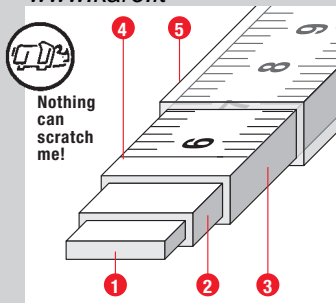

Tape structures

- 1 Concaved, tempered spring blade steel of high stability
- 2 Anticorrosive phosphate coating
- 3 Synthetic resin, stoved
- 4 Printed graduation with red meter figures
- 5 Clear varnish to protect against wear, stoved

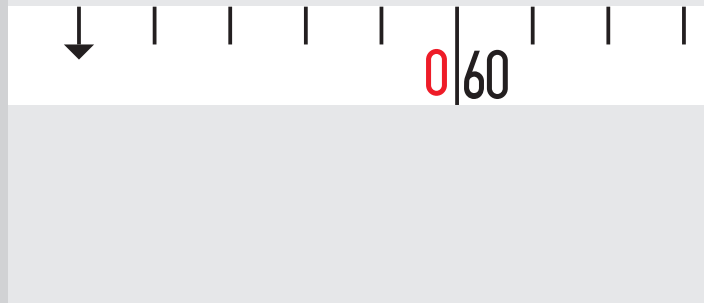

Type	Frame size	Graduation number	Length meter	Measurement commencement	Tape commencement	Price
501	31	X	010	X	X	
501	31	X	015	X	X	
501	31	X	020	X	X	
501	31	X	025	X	X	
501	31	X	030	X	X	
501	32	X	050	X	X	

Type	Frame size	Graduation number	Length meter	Measurement commencement	Tape commencement	Price
501	34	X	100	X	X	

Type	Frame size	Graduation number	Length meter	Measurement commencement	Tape commencement	Price
501	21	X	010	X	X	
501	21	X	015	X	X	
501	21	X	020	X	X	
501	22	X	025	X	X	
501	22	X	030	X	X	
501	23	X	050	X	X	

Type	Frame size	Graduation number	Length meter	Measurement commencement	Tape commencement	Price
501	00	X	001	X	X	
501	00	X	002	X	X	
501	00	X	005	X	X	
501	00	X	010	X	X	
501	00	X	015	X	X	
501	00	X	020	X	X	
501	00	X	025	X	X	
501	00	X	030	X	X	
501	00	X	050	X	X	
501	00	X	100	X	X	

BASIC

Size 1/2



Size 3/4



equal to Standard 3/4

RADIUS case



Replacement tapes

Graduations	
1 (cm)	
4 (mm)	
5 (mm/inch)	

Measurement commencements	
A	
B	
C	
L	

Please order weight separately, see p.13 for model variants

Tape commencements (optional)	
F (FLEXTOP)	
HF (hookring flexible, surcharge)	
M (metal ring)	

for measurement commencement B
for measurement commencement C

Please choose numbers and capital letters of desired tape features and transfer them to your order no.

ISOLAN 13 mm

ISOLAN tape, polyamide coating,
printed graduation

This is how your order no. could look like:

305 01 1 010 A F



ERGOLINE

Size 1/2



Size 3/4



Type	Frame size	Graduation number	Length meter	Measurement commencement	Tape commencement	Price
305	01	X	010	X	X	
305	01	X	015	X	X	
305	01	X	020	X	X	
305	02	X	025	X	X	
305	02	X	030	X	X	

Type	Frame size	Graduation number	Length meter	Measurement commencement	Tape commencement	Price
305	03	X	030	X	X	
305	03	X	050	X	X	
305	04	X	100	X	X	

STANDARD

Size 1/2



Size 3/4



Type	Frame size	Graduation number	Length meter	Measurement commencement	Tape commencement	Price
505	01	X	010	X	X	
505	01	X	015	X	X	
505	01	X	020	X	X	
505	02	X	025	X	X	
505	02	X	030	X	X	

Type	Frame size	Graduation number	Length meter	Measurement commencement	Tape commencement	Price
505	03	X	030	X	X	
505	03	X	050	X	X	
505	04	X	100	X	X	

Please choose numbers and capital letters of desired tape features and transfer them to your order no.

Graduations

1 (cm)	
4 (mm)	
5 (mm/inch) 25% surcharge	

Measurement commencements

A	
B	
C	
L	

Please order weight separately, see p.13 for model variants

Tape commencements (optional)

F (FLEXTOP)	
HF (hookring flexible, surcharge)	
M (metal ring)	

for measurement commencement B
for measurement commencement C

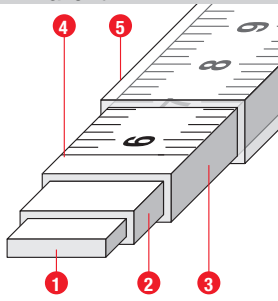

Tape structures

- 1 Tempered spring blade made of carbon steel C 75
- 2 Anticorrosive phosphate layer
- 3 Yellow synthetic resin, stoved
- 4 Printed graduation with red metre digits
- 5 Polyamide coating against wear*

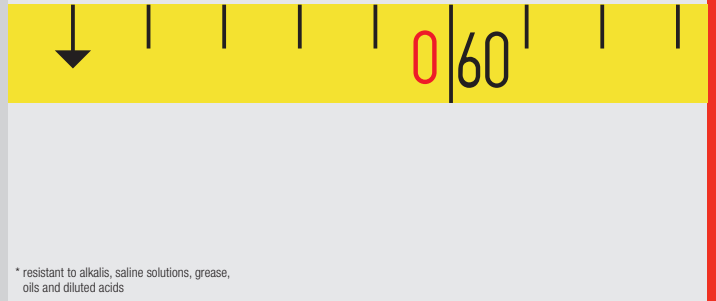

Type	Frame size	Graduation number	Length meter	Measurement commencement	Tape commencement	Price
505	31	X	010	X	X	
505	31	X	015	X	X	
505	31	X	020	X	X	
505	32	X	025	X	X	
505	32	X	030	X	X	

Type	Frame size	Graduation number	Length meter	Measurement commencement	Tape commencement	Price
505	34	X	050	X	X	

Type	Frame size	Graduation number	Length meter	Measurement commencement	Tape commencement	Price
505	21	X	010	X	X	
505	21	X	015	X	X	
505	22	X	020	X	X	
505	22	X	025	X	X	
505	23	X	030	X	X	
505	23	X	050	X	X	

Type	Frame size	Graduation number	Length meter	Measurement commencement	Tape commencement	Price
505	00	X	001	X	X	
505	00	X	002	X	X	
505	00	X	005	X	X	
505	00	X	010	X	X	
505	00	X	015	X	X	
505	00	X	020	X	X	
505	00	X	025	X	X	
505	00	X	030	X	X	
505	00	X	050	X	X	
505	00	X	100	X	X	

BASIC

Size 1/2



Size 3/4



equal to Standard 3/4

RADIUS case



Replacement tapes

Graduations

1 (cm)	
4 (mm)	
5 (mm/inch)	

25% surcharge

Measurement commencements



Tape commencements (optional)

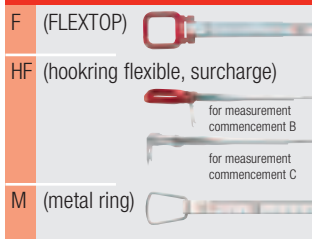

Please choose numbers and capital letters of desired tape features and transfer them to your order no.

PONTARIT 13 mm



This is how your order no. could look like:

315 01 1 010 A F

PONTARIT stainless steel tape, printed graduation

ERGOLINE		Type	Frame size	Graduation number	Length meter	Measurement commencement	Tape commencement	Price
Size 1/2		315	01	X	010	X	X	
		315	01	X	015	X	X	
		315	01	X	020	X	X	
		315	02	X	025	X	X	
		315	02	X	030	X	X	
		315	02	X	050	X	X	
Size 3/4		315	03	X	050	X	X	
		315	04	X	100	X	X	
STANDARD		Type	Frame size	Graduation number	Length meter	Measurement commencement	Tape commencement	Price
Size 1/2		515	01	X	010	X	X	
		515	01	X	015	X	X	
		515	01	X	020	X	X	
		515	02	X	025	X	X	
		515	02	X	030	X	X	
		515	02	X	050	X	X	
Size 3/4		515	03	X	050	X	X	
		515	04	X	100	X	X	

Please choose numbers and capital letters of desired tape features and transfer them to your order no.

Graduations	
1 (cm)	
4 (mm)	

Measurement commencements	
A	
B	
C	
L	

Please order weight separately, see p.13 for model variants

Tape commencements (optional)	
F (FLEXTOP)	
HF (hookring flexible, surcharge)	
M (metal ring)	

for measurement commencement B
for measurement commencement C

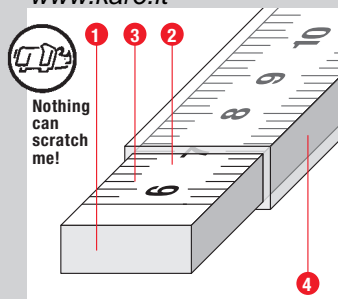

Tape structures

- 1 Strain-hardened spring blade made of stainless chrome nickel steel
- 2 Matt-pickled surface
- 3 Printed graduation with red metre digits
- 4 Clear varnish against wear, stoved



Type	Frame size	Graduation number	Length meter	Measurement commencement	Tape commencement	Price
515	31	X	010	X	X	
515	31	X	015	X	X	
515	31	X	020	X	X	
515	31	X	025	X	X	
515	31	X	030	X	X	
515	32	X	050	X	X	

Type	Frame size	Graduation number	Length meter	Measurement commencement	Tape commencement	Price
515	34	X	100	X	X	

Type	Frame size	Graduation number	Length meter	Measurement commencement	Tape commencement	Price
515	21	X	010	X	X	
515	21	X	015	X	X	
515	21	X	020	X	X	
515	22	X	025	X	X	
515	22	X	030	X	X	
515	23	X	050	X	X	

Type	Frame size	Graduation number	Length meter	Measurement commencement	Tape commencement	Price
515	00	X	010	X	X	
515	00	X	015	X	X	
515	00	X	020	X	X	
515	00	X	025	X	X	
515	00	X	030	X	X	
515	00	X	050	X	X	
515	00	X	100	X	X	

BASIC

Size 1/2



Size 3/4



equal to Standard 3/4

RADIUS case



Replacement tapes

Graduations



Measurement commencements



Tape commencements (optional)

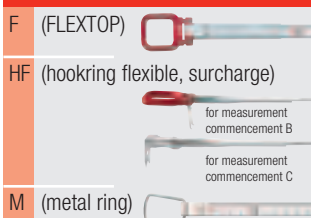

Please choose numbers and capital letters of desired tape features and transfer them to your order no.

High etched 13 mm



This is how your order no. could look like:

309 01 1 010 A F

High etched stainless steel tape

ERGOLINE

Size 1/2



Type	Frame size	Graduation number	Length meter	Measurement commencement	Tape commencement	Price
309	01	X	010	X	X	
309	01	X	015	X	X	
309	01	X	020	X	X	
309	02	X	025	X	X	
309	02	X	030	X	X	
309	02	X	050	X	X	

Size 3/4



Type	Frame size	Graduation number	Length meter	Measurement commencement	Tape commencement	Price
309	03	X	050	X	X	
309	04	X	100	X	X	

STANDARD

Size 1/2



Type	Frame size	Graduation number	Length meter	Measurement commencement	Tape commencement	Price
509	01	X	010	X	X	
509	01	X	015	X	X	
509	01	X	020	X	X	
509	02	X	025	X	X	
509	02	X	030	X	X	
509	02	X	050	X	X	

Size 3/4



Type	Frame size	Graduation number	Length meter	Measurement commencement	Tape commencement	Price
509	03	X	050	X	X	
509	04	X	100	X	X	

Brass frame series



including weight 476
Please see p.13 for description,
suitable for calibration

Type	Frame size	Graduation number	Length meter	Measurement commencement	Tape commencement	Price
309	12	4	010	L	476	
309	12	4	015	L	476	
309	12	4	020	L	476	
309	12	4	025	L	476	
309	12	4	030	L	476	
309	12	4	050	L	476	

Please choose numbers and capital letters of desired tape features and transfer them to your order no.

Graduations

1 (cm)	
4 (mm)	
5 (mm/inch) 25% surcharge	

Measurement commencements

A	
B	
C	
L	

Please order weight separately, see p.13 for model variants

Tape commencements (optional)

F (FLEXTOP)	
HF (hookring flexible, surcharge)	
M (metal ring)	

for measurement commencement B
for measurement commencement C

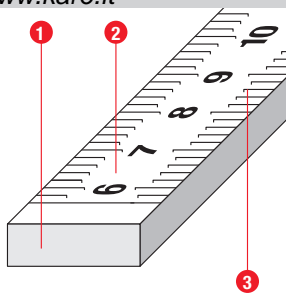

Tape structures

- 1 Strain-hardened spring blade made of stainless chrome steel
- 2 Lowered, etched surface
- 3 Raised, polished graduation

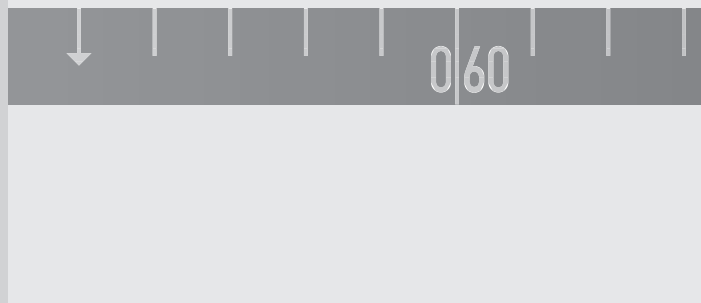

Type	Frame size	Graduation number	Length meter	Measurement commencement	Tape commencement	Price
509	31	X	010	X	X	
509	31	X	015	X	X	
509	31	X	020	X	X	
509	31	X	025	X	X	
509	31	X	030	X	X	
509	32	X	050	X	X	

Type	Frame size	Graduation number	Length meter	Measurement commencement	Tape commencement	Price
509	34	X	100	X	X	

Type	Frame size	Graduation number	Length meter	Measurement commencement	Tape commencement	Price
509	21	X	010	X	X	
509	21	X	015	X	X	
509	21	X	020	X	X	
509	22	X	025	X	X	
509	22	X	030	X	X	
509	23	X	050	X	X	

Type	Frame size	Graduation number	Length meter	Measurement commencement	Tape commencement	Price
509	00	X	010	X	X	
509	00	X	015	X	X	
509	00	X	020	X	X	
509	00	X	025	X	X	
509	00	X	030	X	X	
509	00	X	050	X	X	
509	00	X	100	X	X	

BASIC

Size 1/2



Size 3/4



equal to Standard 3/4

RADIUS case



Replacement tapes

Graduations	
1 (cm)	
4 (mm)	
5 (mm/inch)	

25% surcharge

Measurement commencements	
A	
B	
C	
L	

Please order weight separately, see p.13 for model variants

Tape commencements (optional)	
F (FLEXTOP)	
HF (hookring flexible, surcharge)	
M (metal ring)	

for measurement commencement B
for measurement commencement C

Please choose numbers and capital letters of desired tape features and transfer them to your order no.

Plastic 13 mm



This is how your order no. could look like:

320 01 1 010 A

Plastic measuring tape, glass fibre reinforced

ERGOLINE

Size 1/2



Size 3/4



Type	Frame size	Graduation number	Length meter	Measurement commencement	Tape commencement	Price
320	01	X	010	X	X	
320	02	X	015	X	X	
320	02	X	020	X	X	
320	02	X	025	X	X	

Type	Frame size	Graduation number	Length meter	Measurement commencement	Tape commencement	Price
320	03	X	030	X	X	
320	04	X	050	X	X	

STANDARD

Size 1/2



Size 3/4



Type	Frame size	Graduation number	Length meter	Measurement commencement	Tape commencement	Price
520	01	X	010	X	X	
520	02	X	015	X	X	
520	02	X	020	X	X	
520	02	X	025	X	X	

Type	Frame size	Graduation number	Length meter	Measurement commencement	Tape commencement	Price
520	03	X	030	X	X	
520	03	X	050	X	X	
520	04	X	100	X	X	

Please choose numbers and capital letters of desired tape features and transfer them to your order no.

Graduations

1 (cm)	
2 (cm/cm)	
3 (cm/inch) 25% surcharge	

Measurement commencements

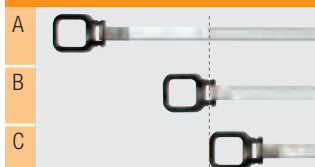

Tape commencements (optional)



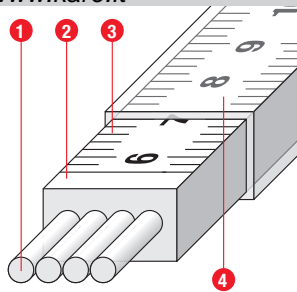

Tape structures

- 1 Glass fibres
- 2 Extruded plastic coating
- 3 Printed graduation with red metre digits
- 4 Varnished against wear



Type	Frame size	Graduation number	Length meter	Measurement commencement	Tape commencement	Price
520	31	X	010	X	X	
520	31	X	015	X	X	
520	32	X	020	X	X	
520	32	X	025	X	X	

Type	Frame size	Graduation number	Length meter	Measurement commencement	Tape commencement	Price
520	33	X	030	X	X	
520	34	X	050	X	X	
520	34	X	100	X	X	

Type	Frame size	Graduation number	Length meter	Measurement commencement	Tape commencement	Price
520	21	X	010	X	X	
520	22	X	015	X	X	
520	22	X	020	X	X	
520	23	X	025	X	X	
520	23	X	030	X	X	

Type	Frame size	Graduation number	Length meter	Measurement commencement	Tape commencement	Price
520	00	X	010	X	X	
520	00	X	015	X	X	
520	00	X	020	X	X	
520	00	X	025	X	X	
520	00	X	030	X	X	
520	00	X	050	X	X	
520	00	X	100	X	X	

BASIC

Size 1/2



Size 3/4



equal to Standard 3/4

RADIUS case



Replacement tapes

Graduations

1	(cm)	
2	(cm/cm)	
3	(cm/inch)	

25% surcharge

Measurement commencements

A	
B	
C	

Tape commencements (optional)

H	(hookring) surcharge	
		for measurement commencement B
		for measurement commencement C

Please choose numbers and capital letters of desired tape features and transfer them to your order no.

Deep etched 13 mm

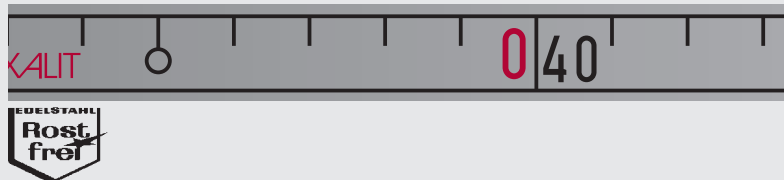

This is how your order no. could look like:

317 01 1 010 A F

LEXALIT stainless steel tape, etched graduation

ERGOLINE

Size 1/2



Size 3/4



Type	Frame size	Graduation number	Length meter	Measurement commencement	Tape commencement	Price
317	01	1	010	X	X	
317	01	1	015	X	X	
317	01	1	020	X	X	
317	02	1	025	X	X	
317	02	1	030	X	X	
317	02	1	050	X	X	

Type	Frame size	Graduation number	Length meter	Measurement commencement	Tape commencement	Price
317	03	1	050	X	X	

Please choose numbers and capital letters of desired tape features and transfer them to your order no.

Graduations

1 (cm) 0.60

Measurement commencements

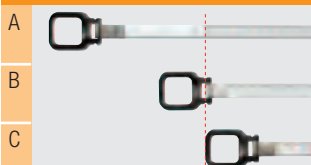

Tape commencements (optional)

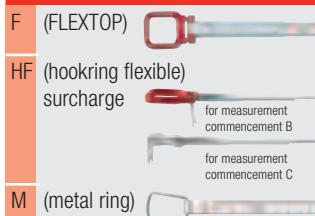

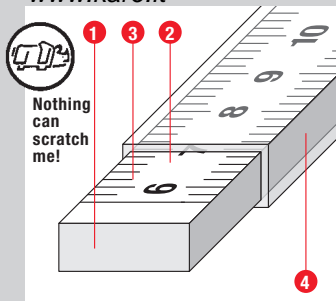

Tape structures

- 1 Tempered spring blade made of stainless chrome steel
- 2 Polished surface
- 3 Deep-etched, black graduation
- 4 Clear varnish against wear, stoved



Type	Frame size	Graduation number	Length meter	Measurement commencement	Tape commencement	Price
517	21	1	010	X	X	
517	21	1	015	X	X	
517	21	1	020	X	X	
517	22	1	025	X	X	
517	22	1	030	X	X	
517	23	1	050	X	X	

RADIUS case



Type	Frame size	Graduation number	Length meter	Measurement commencement	Tape commencement	Price
517	00	1	005	X	X	
517	00	1	010	X	X	
517	00	1	015	X	X	
517	00	1	020	X	X	
517	00	1	025	X	X	
517	00	1	030	X	X	
517	00	1	050	X	X	

Replacement tapes

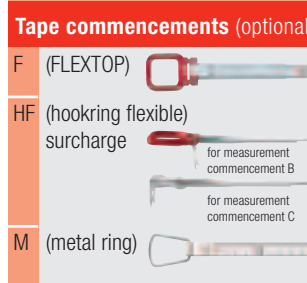
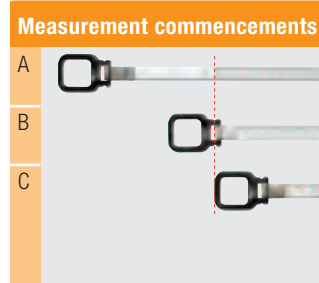
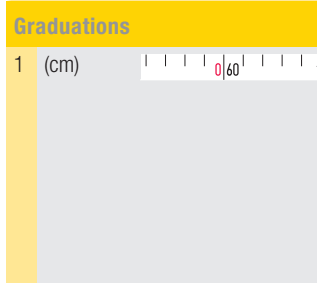

Please choose numbers and capital letters of desired tape features and transfer them to your order no.

Order survey tape quality

White enamelled, 10 mm



This is how your order no. could look like:

303 17 4 010 A M

White enamelled measuring tape, printed graduation

555 case series



Type	size of case	Graduation number	Length meter	Measurement commencement	Tape commencement	Price
303	17	4	010	X	X	
303	17	4	020	X	X	
303	17	4	030	X	X	

Please choose numbers and capital letters of desired tape features and transfer them to your order no.

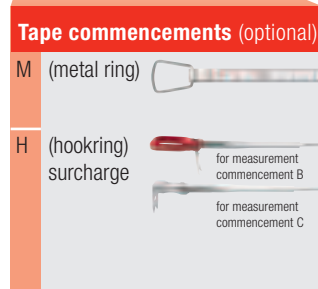
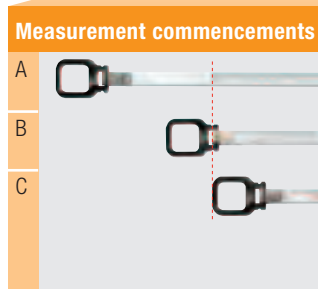
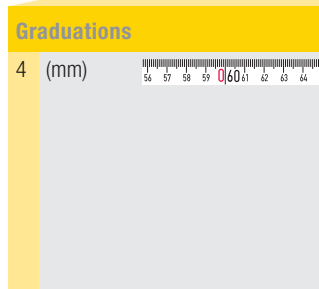

Order survey tape quality

High etched 13 mm



Tank dipping tapes according to IPM specification
High etched measuring tape

according to IPM specification



including weight 31, please see p.13 for description, mm graduation

Type	Frame size	Graduation number	Length meter	Measurement commencement	Tape commencement	Price
312	11	4	010	L	31	
312	11	4	020	L	31	
312	11	4	030	L	31	
312	11	4	050	L	31	

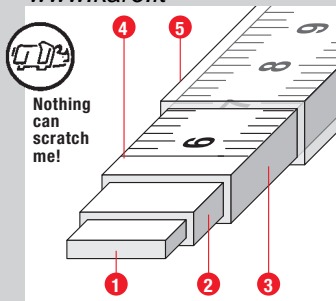

Tape structures

- 1 Tempered spring blade made of carbon steel C 75
- 2 Anticorrosive phosphate layer
- 3 White synthetic resin, stoved
- 4 Printed graduation with red metre digits
- 5 Clear varnish against wear, stoved

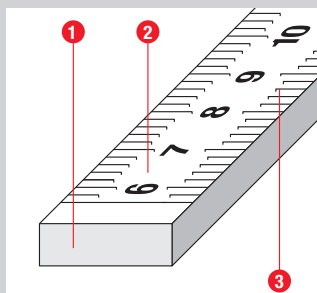
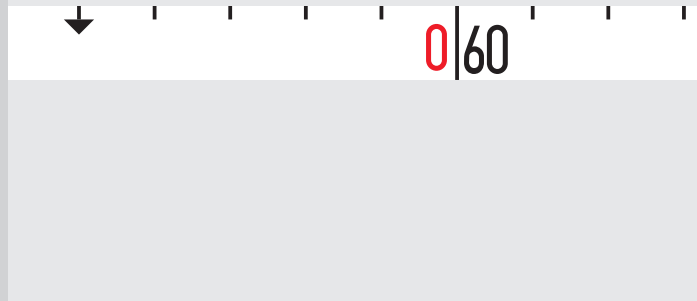

Tape structures

- 1 Strain-hardened spring blade made of stainless chrome steel
- 2 Lowered, etched surface
- 3 Raised, polished graduation

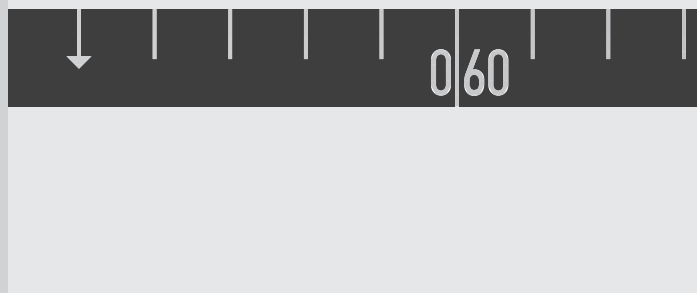

Custom made measuring tapes

For example self adhesive tapes with graduation from right to left side

We are pleased to produce custom made measuring tapes for you. Please contact us!